

VERDERFLEX **DURA**

Industrial Peristaltic Hose Pumps

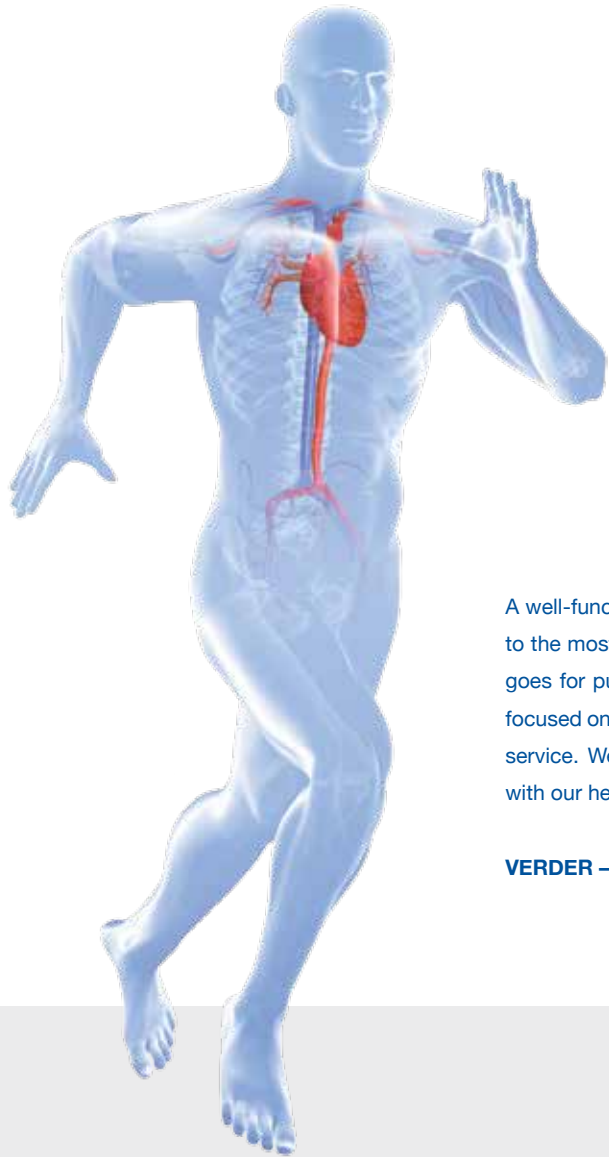



A well-functioning pump helps you succeed. That applies certainly to the most important pump in life, the human heart, but the same goes for pumps in business. At Verder, all energy and attention is focused on improving the quality and performance of our pump and service. We do so with energy, dedication and most importantly, with our heart.

VERDER – PASSION FOR PUMPS

COMPACT. INNOVATIVE. RELIABLE.

The Verderflex Dura peristaltic pump achieves the highest performance with the smallest possible footprint. The innovative design of the Verderflex Dura with a vertical motor ensures minimal space requirement and optimally cools the pump housing and hose.

COMPACT: REQUIRES UP TO 70% LESS FLOOR SPACE THAN OTHER PERISTALTIC PUMPS!

INNOVATIVE: DESIGNED TO MAKE HOSE CHANGES FAST AND SIMPLE!

RELIABLE: BOTH THE CONSTRUCTION AND PERFORMANCE PROVIDE A LONG PRODUCT LIFE AND PRECISE DOSING!

With the Verderflex Dura pump you experience a fast and easy hose change because of its unique connection system.

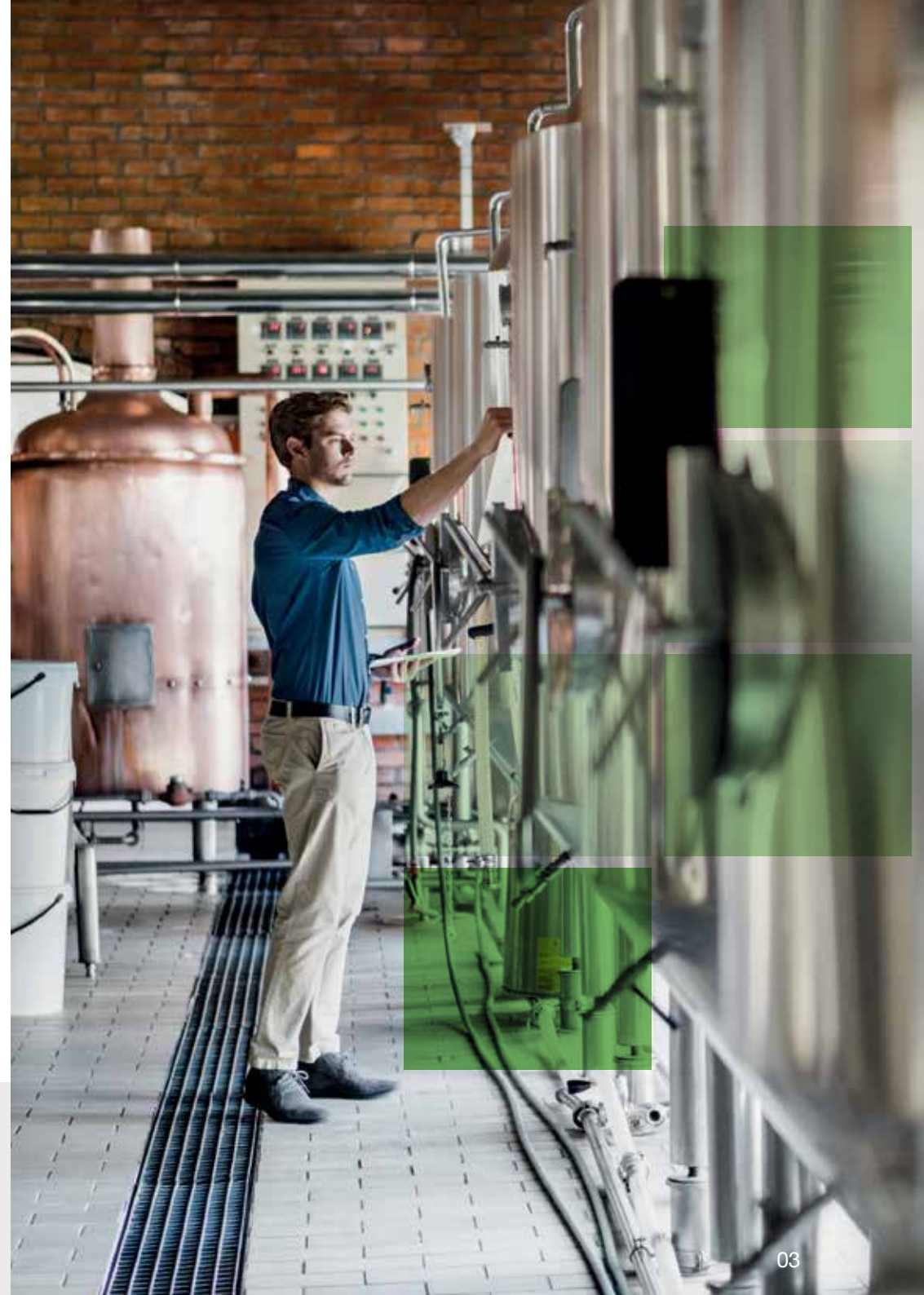

VERDERFLEX[®] DURA



RELIABLE
A NEW STANDARD FOR
INDUSTRIAL PROCESS
PERISTALTIC PUMPS



Peristaltic pumps are the ideal solution for many different applications. Due to their unique working principle these pumps can be used in the most diverse industries for a huge range of fluids and system conditions.

The hose is the only component which comes into contact with the fluid. This reduces abrasive wear on other working parts which both dramatically extends the life of the pump and makes it ideal for handling abrasive, viscous and solid-laden media.

The Verderflex Dura is the trusted name to pump difficult chemicals for clean and waste water treatment in municipal works and commercial premises.

- **Only the hose is in contact with the fluid**
- **Fast hose change**
- **Requires up to 70% less floor space**
- **Special long life hose design**
- **Optimal transmission protection with the compactness of close coupled design**

INNOVATIVE TECHNICAL FEATURES

The innovative design of the Verderflex Dura pumps with a vertical motor ensures minimal space requirement and isolates the pump housing and hose. The pump is fixed on the shaft by means of a feather key, reliably transmitting the torque to the rotor with seals to prevent any pumping media from entering the gearbox and motor.

The sealed for life bearings eliminate periodic maintenance and are over-rated for the pump's radial load for a much quieter and smoother operation, extending the life of the pump and gearbox.

The specially designed hose reduces power consumption by minimizing the compressed hose's torque requirements. The amount of heat produced is much lower, which significantly increases hose life.

- **Air gap between the pumphead and motor**
- **The rotor is centrally located over the bearing**
- **Smoother running leads to longer life**
- **Reduced radial forces minimise power consumption**

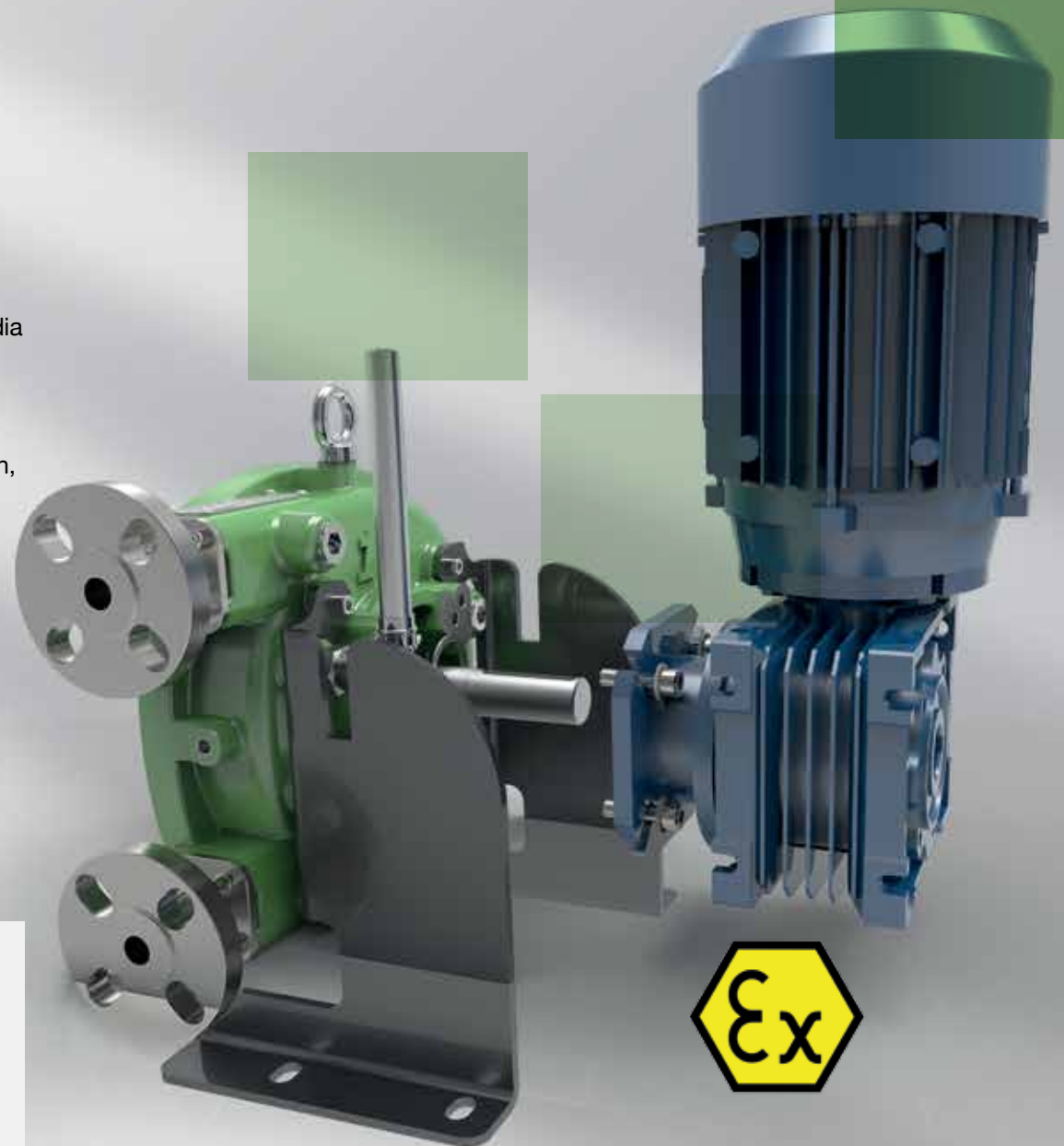

**WE CAN OFFER YOU AN
ATEX CERTIFICATE FOR ALL
DURA PUMPS.**

Gearbox is totally isolated from pump head

Sealed bearings for reduced maintenance

Low heat generation for longer hose life

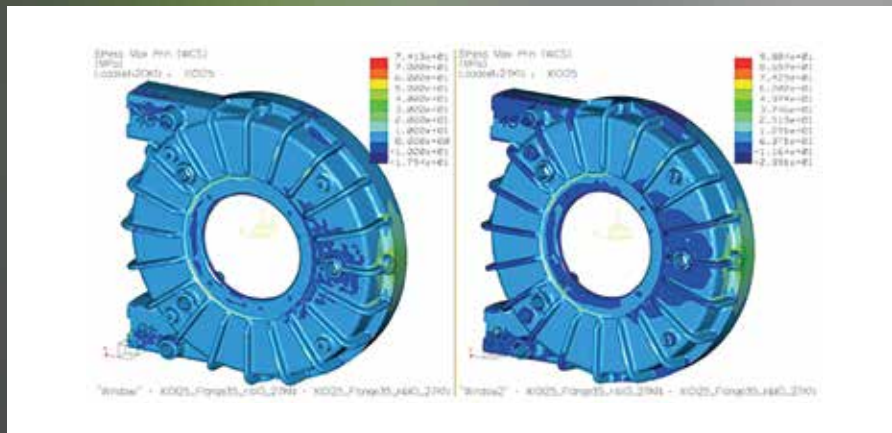

The heat generated by the motor is isolated from the heat of the casing, a cooler running hose is a key component for long hose life.



- **Easy hose change**
- **Custom-fit hose length, no need to trim**
- **Hose is completely enclosed in the pump**
- **Innovative flanges available in stainless steel, PP and PVDF**
- **Robust, fibre-reinforced hose for long hose and high working pressures**



**SIMPLE & FAST
HOSE CHANGE**



**PRODUCT VIDEOS AT
WWW.VERDERLIQUIDS.COM**

INNOVATIVE FLANGE DESIGN

The new, innovative flange design makes the Dura peristaltic pump even safer. The conical flange insert presses the hose against the housing's internal taper for secure hose clamping inside the casing.

ROBUST AND UNIVERSAL FIT:

Universal flange design fits DIN PN16, ANSI 150 and JIS 10K pipework

For applications involving aggressive chemicals such as sodium hypochlorite and ferric chloride, non-metallic inserts of PP and PVDF are available.

FASTER, EASIER AND SAFER:

Hose changes without clamps

The flexible hose is fiber-reinforced with a special surface, designed to minimize friction from the rotor, extending the life of the hose. In the event of a hose failure, the liquid is completely contained within the casing, preventing risk to any surrounding employees. Thanks to the custom-fit hose length, there is no shortening necessary. The universal flange is suitable for DIN, ANSI and JIS connections.



COMPACT & POWERFUL

The Verderflex Dura requires a significantly smaller footprint compared to conventional peristaltic pumps. The graph picture shows the footprint of the Dura 10 in comparison with a model of traditional construction.

Although the Dura pumps are of a smaller size, they realize the same or higher flow than comparable pumps.

Powerful - the highest flow rate

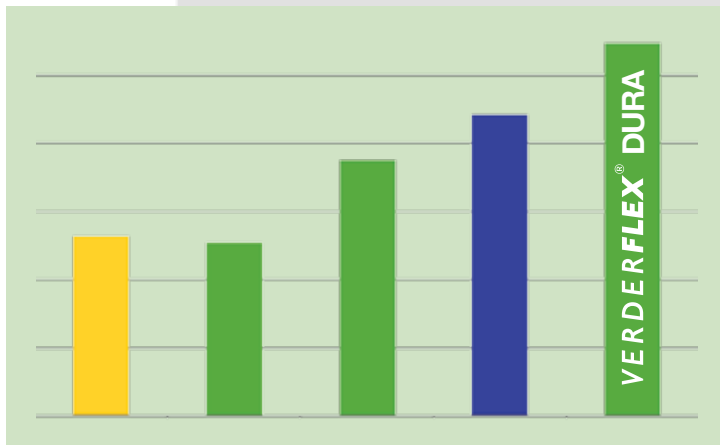

Looking at some of the comparable peristaltic pumps on the market we can see the Verderflex Dura has the highest flow rate!

- Highest performance with the smallest footprint
- Compact dosing
- Discharge pressures up to 16 bar
- Close coupled with air gap for gearbox protection
- Dry self priming up to 9.5 mWc

Compact - the smallest footprint

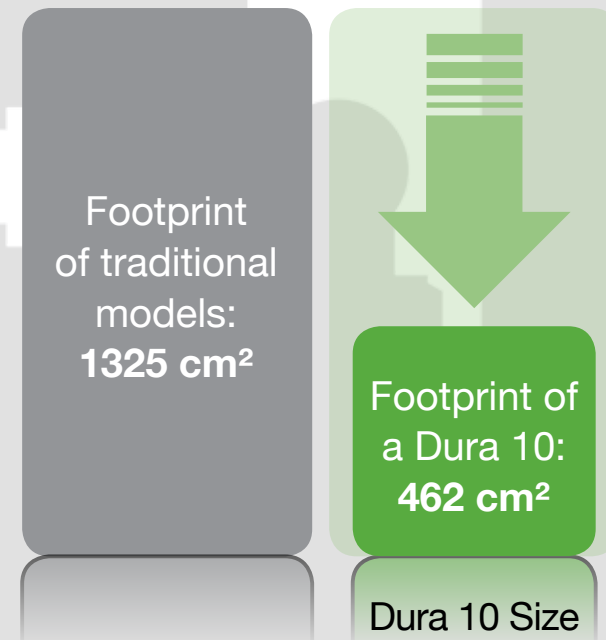

1:1 REPRESENTATION OF THE FOOTPRINT
(VERDERFLEX DURA 5-10)

OPTIONS & EQUIPMENT

❶ Inverters

For variable speed dosing, the use of an inverter allows the speed of the pump to be remote controlled using signals from sources including pH meters for proportional dosing when the host media changes. Verderflex Dura pumps are commonly used with inverters for dosing of lime, sodium hypochlorite and other chemicals for water and wastewater treatment.

❷ Pulsation Dampeners

Pumps such as peristaltic hose and air diaphragm models operate through displacement, often generating a pulsing flow. Over a prolonged period, this can damage pipework or system elements. A pulsation dampener smoothes out these fluctuations, reduces energy requirements and protects your system.

❸ Burst hose detection

Mounted onto the pump casing, a calibrated sensor recognizes a rise in pressure. Once the pressure limit is reached the sensor changes the status, and an alarm will be sent and/or the pump can be shut-off automatically, preventing damage.





**EXCEPTIONAL CONSTRUCTION:
Fibre-reinforced with uniform
wall thickness**



- Higher elasticity
- Up to 15 million compressions
- Wide material range for optimum chemical compatibility
- Uniform wall thickness
- Special surface for optimal lubrication
- Pre-cut length for easy installation

**ADVANCED HOSE DESIGN
QUALITY & DURABLE**

During hose development, special attention was paid to maximise the fatigue resistance. This resulted in the Verderflex hose's extended service life.

Every Verderflex hose is made in a precision manufacturing process that maintains wall thickness consistency, eliminating unnecessary surface machining. The hose surface has a textured finish that optimises lubricant distribution for minimum surface friction and lower casing temperature.

All hoses have a clear, colour coded material and model identification stripe on its surface, eliminating incorrect material usage.

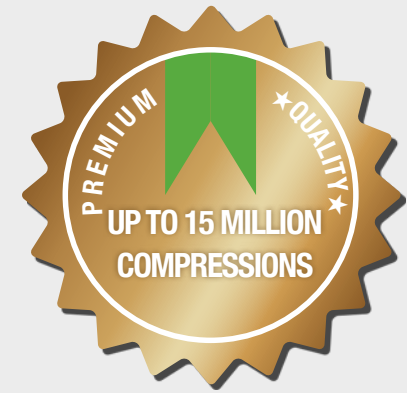

VERDER pump hoses are made of high quality materials. High-tech fiber materials ensure optimal hose reinforcement.

	NR	NBR	NBRF	EPDM	CSM, Hypalon®	Verderprene
Material	Natural Rubbe	Nitrile-Buna Rubber	Nitrile-Buna Rubber (FDA/EN1935)	Ethylene- polypropylene Diene Rubber	Chlorosulfonated polyethylene	Thermoplastic from Santoprene (FDA)
Suitable for	low aggressive chemicals, strong abrasive sludges, anorganic fluids	oily, greasy organic fluids	food	corrosive, diffusing chemicals, inorganic liquids	high corrosive fluids such as oxidants	almost all acids, bases, salts, ketones and alcohols
Colour code	white	yellow	white/yellow	red	green	none
Temperature	-20 °C up to +80 °C	-20 °C up to +80 °C	-20 °C up to +80 °C	-20 °C up to +100 °C short term up to 120 °C)	+5 °C up to +85 °C	+5 °C up to +85 °C
Max. pressure	16 bar	16 bar	16 bar	16 bar	16 bar	3 bar

DURA SERIES – TECHNOLOGY ON THE SPOT

	HPLV: High pressure – low volume			
	DURA 5	DURA 7	DURA 10	DURA 15
				
Max. flow rate	23 l/h	39 l/h	222 l/h	593 l/h
Max. speed	70 rpm	70 rpm	160 rpm	130 rpm
Max. discharge pressure	8 bar	8 bar	12 bar	12 bar
Max. solids size	1,25 mm	1,75 mm	2,5 mm	3,75 mm
Weight (with motor) approx.	ca. 28 kg	ca. 28 kg	ca. 28 kg	ca. 44 kg
Interchangeable flange inserts	✓	✓	✓	✓
Universal flange	✓	✓	✓	✓
Rotor for high and low pressure	✓	✓	✓	✓
Dosing of low flow rates	✓	✓	-	-
Suitable for abrasive media	✓	✓	✓	✓
Slip clutch	-	-	-	-

	DURA 25	DURA 35	DURA 45	DURA 55
				
Max. flow rate	2.387 l/h	5.292 l/h	12.240 l/h	15.300 l/h
Max. speed	140 rpm	140 rpm	120 rpm	80 rpm
Max. discharge pressure	12 bar	16 bar	16 bar	16 bar
Max. solids size	6,25 mm	8,75 mm	11,25 mm	13,75 mm
Weight (with motor) approx.	ca. 71 kg	ca. 97 kg	ca. 160 kg	ca. 430 kg
Interchangeable flange inserts	✓	✓	✓	✓
Universal flange	✓	✓	✓	✓
Rotor for high and low pressure	✓	✓	-	-
Dosing of low flow rates	-	-	-	-
Suitable for abrasive media	✓	✓	✓	✓
Slip clutch	-	-	✓	✓

DURA SERIES – FLOW RATES AT A GLANCE

Instructions

- 1 Select the required flow rate at the horizontal axis (X axis). This is the required speed of the pump.
- 2 From this point go up until you reach the color line that corresponds to your calculated pressure.
- 3 At this point on the vertical (Y) axis at the left, you can see the required motor power.

DURA 5

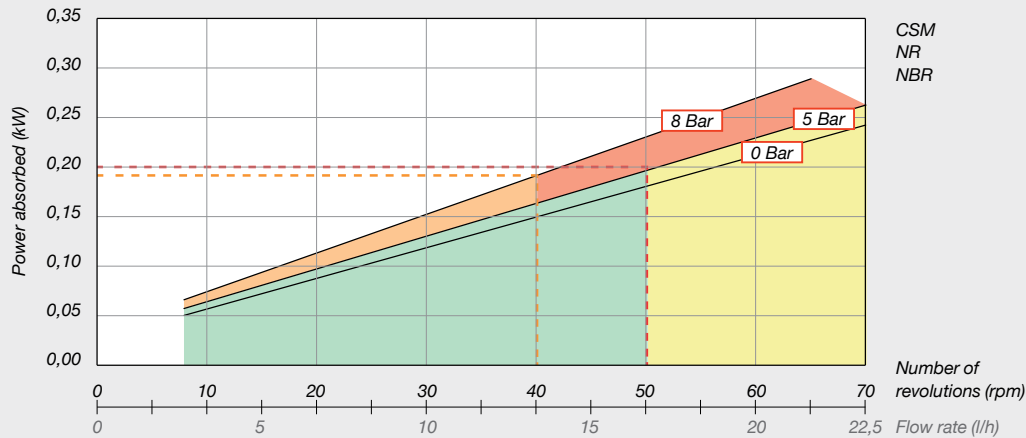

DURA 7

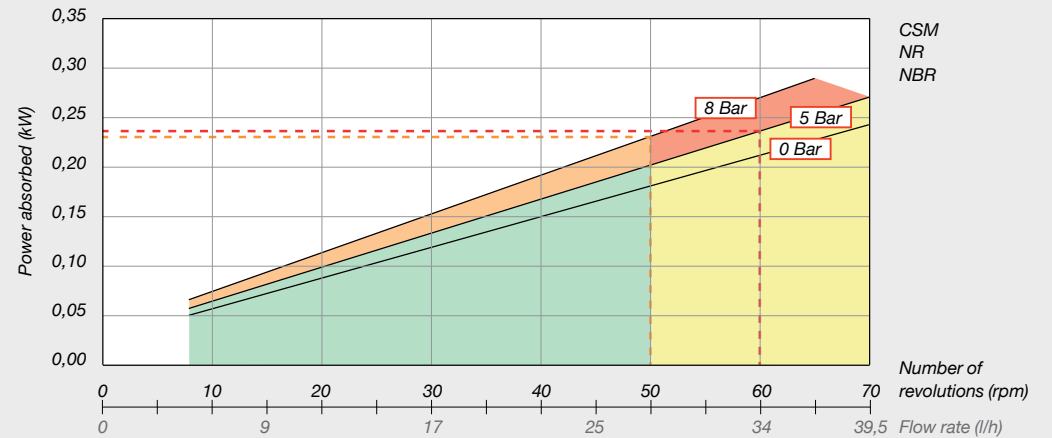

DURA 10

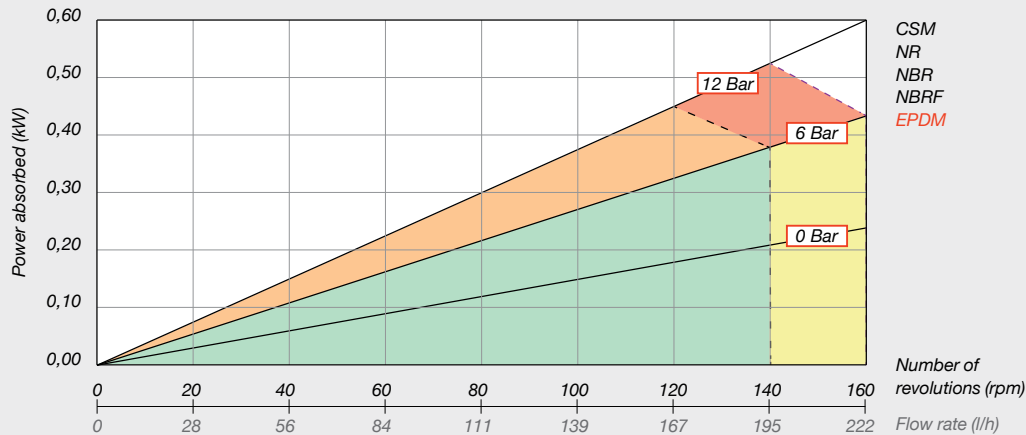

DURA 15

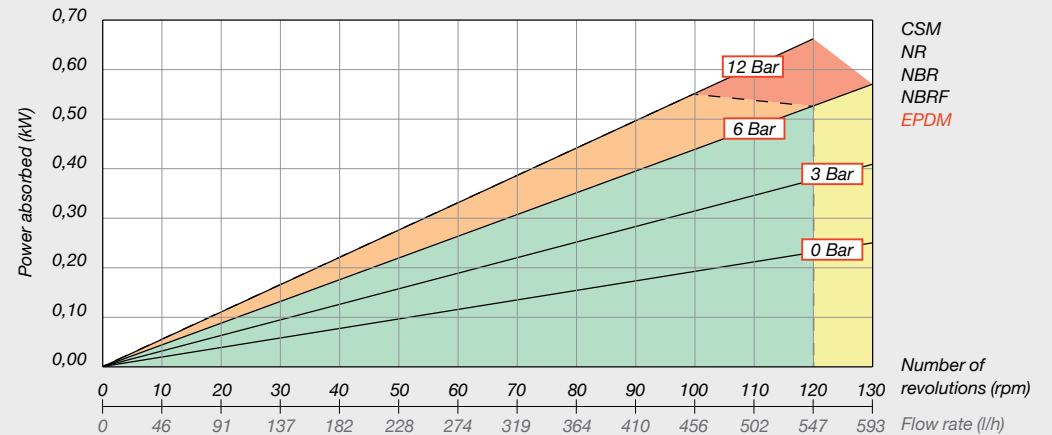

- Continuous duty Standard rotor
- Intermittent duty standard rotor
Max. 1 h running
Max. 1 h pause
- Continuous duty High pressure rotor
- Intermittent duty high pressure rotor
Max. 1 h running
Max. 1 h pause

DURA 25

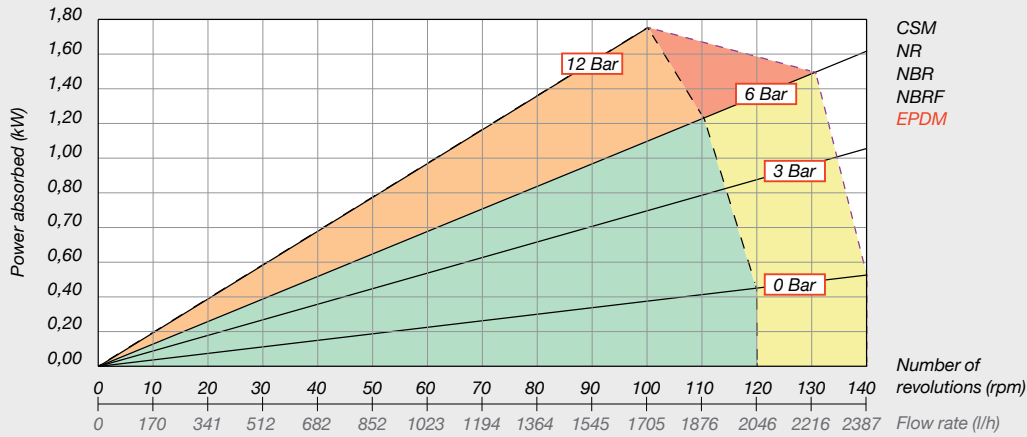

DURA 35

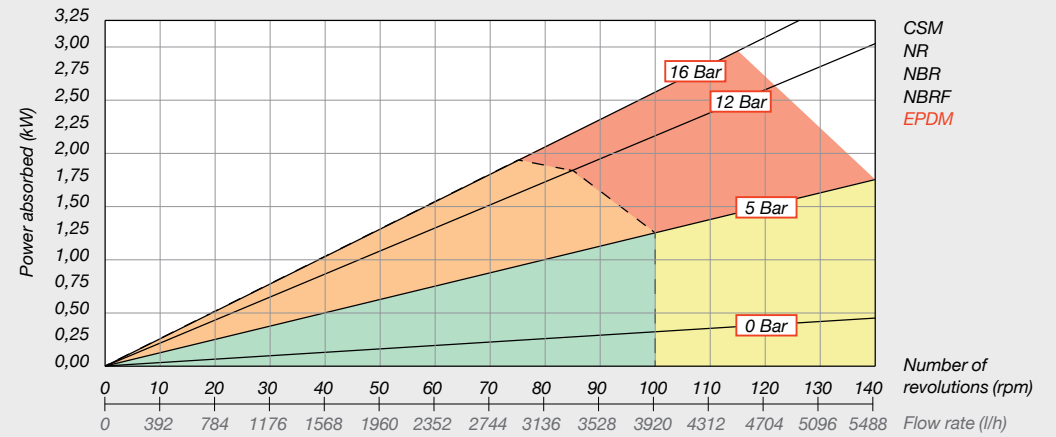

DURA 45

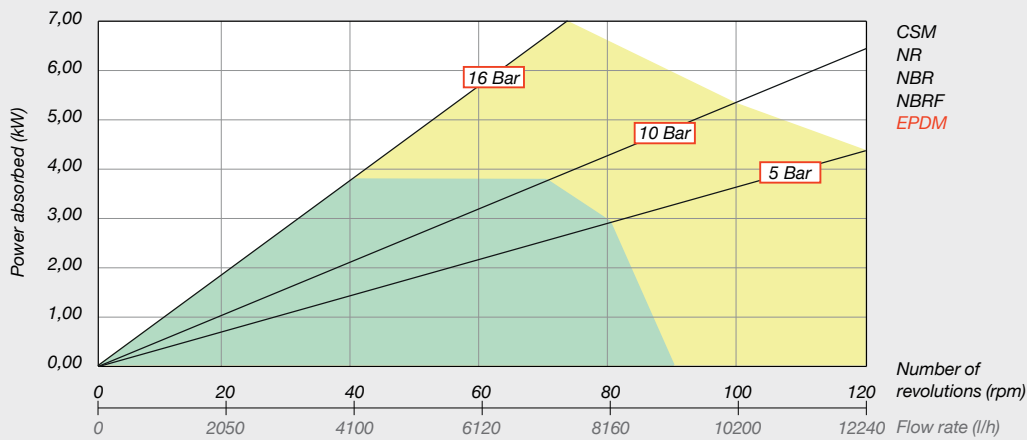

DURA 55

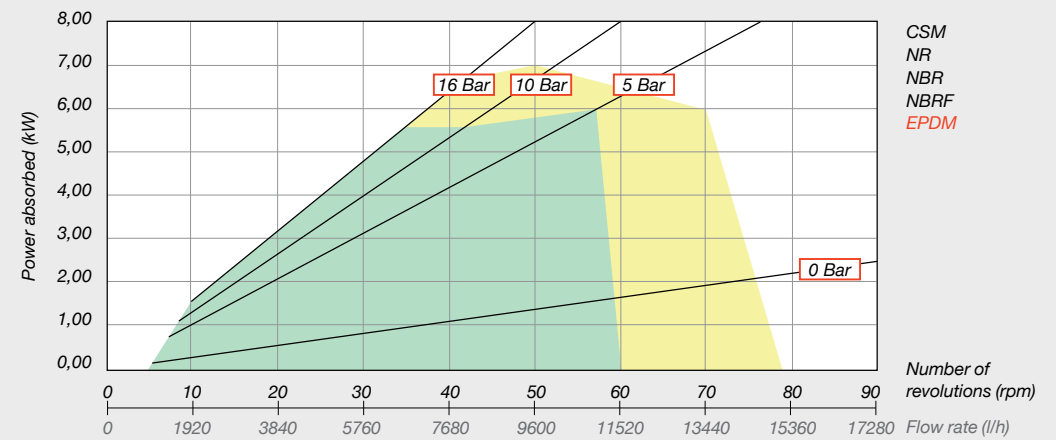

VERDERFLEX[®]

VF

- Proven peristaltic pump for up to 90 m³/h
- Robust, reinforced hoses for long service life
- Simple connection with universal flange
- Hose options: NR, NBR, NBRF, EPDM and CSM
- Gentle pumping of high viscous and shear sensitive liquids

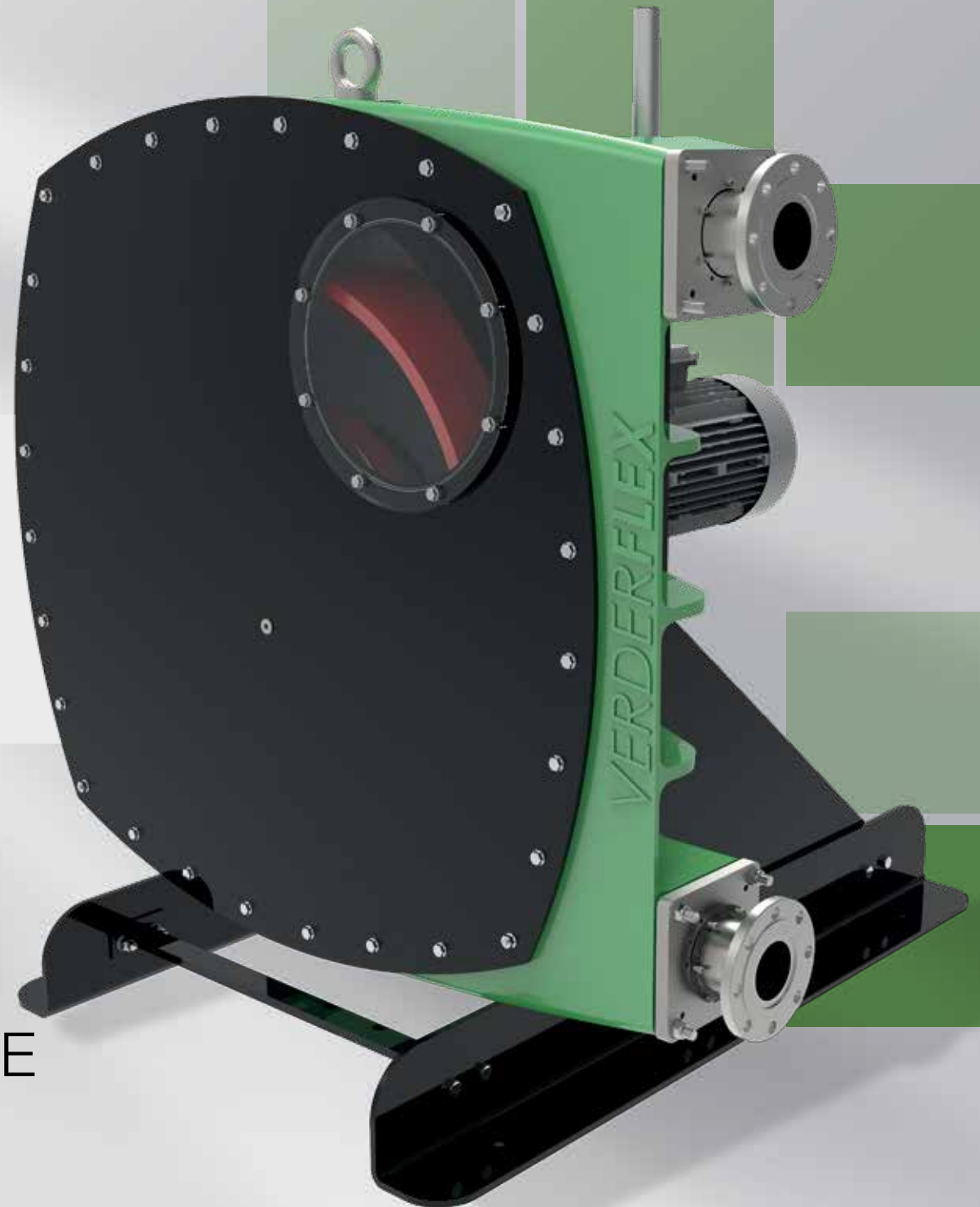

PROVEN PERFORMANCE
RELIABLE STANDARD

Verderflex VF peristaltic pump

The Verderflex VF peristaltic pump is a versatile pump. Over the years the pumps have proven themselves as real problem solvers in a wide variety of applications. With the extensive choice of hose materials the pump can be optimally adapted to the requirements of an application.

The Verderflex VF series enables flow rates of just a few litres per hour up to 90 m³/h at pressures up to 16 bar. The Verderflex VF125 is the biggest proven high pressure industrial hose pump at the world market!

	VF 65	VF 80	VF 100	VF 125
Max. flow rate	25.5 m ³ /h	40 m ³ /h	55 m ³ /h	90 m ³ /h
Max. number of revolutions	70 rpm	60 rpm	50 rpm	45 rpm
Max. discharge pressure	16 bar	16 bar	16 bar	16 bar
Max. temperature	100°C	100°C	100°C	100°C
Max. solids size	16.25 mm	20 mm	25 mm	31.25 mm
Weight	910 kg	1.075 kg	2.400 kg	3.200 kg
Adjustable pressing shoes	✓	✓	✓	✓
Lubricant drain	✓	✓	✓	✓
ATEX	✓	✓	✓	✓





VERDERFLEX, VERDER LTD

Unit 3 California Drive
Castleford - WF10 5QH
United Kingdom

TEL +44 (0)1924 221 020

FAX +44 (0)1132 465 649

MAIL info@verderflex.com

WEB www.verderflex.com

**AUSTRIA / BELGIUM / BULGARIA / CHINA / CROATIA / CZECH REPUBLIC
GERMANY / DENMARK / FRANCE / HUNGARY / INDIA / ITALY / THE
NETHERLANDS / POLAND / ROMANIA / SLOVAKIA / THAILAND / UNITED
KINGDOM / USA / SERBIA / SLOVENIA / SOUTH AFRICA / SWITZERLAND**